



## Overview

Thank you for purchasing Ubiquiti TOUGHCable PRO cabling.

Ubiquiti offers two different types of industrial-grade TOUGHCable Ethernet Cabling in 1000ft (304.8m) lengths and 24 American Wire Gauge (AWG):

- **TOUGHCable PRO** Level 1 Category 5e Outdoor Carrier Class Shielded Cable
- **TOUGHCable CARRIER** Level 2 Category 5e Outdoor Carrier Class Shielded Cable that features an *Anti-Crosstalk Divider*, additional shielding, and is designed to provide optimal performance on Gigabit Ethernet networks

## TOUGHCable Ethernet Connectors

Ubiquiti TOUGHCable Ethernet Connectors (sold separately) are specifically designed for use with Ubiquiti TOUGHCable Ethernet Cabling and are offered in 100 count packages. Some of the benefits include:

- Help to protect against Ethernet Electrostatic Discharge (ESD) attacks and Ethernet hardware damage
- Allow rapid field deployment without soldering

## Installation Requirements

- TOUGHCable Ethernet Cabling
- TOUGHCable Ethernet Connectors
- Wire Strippers/Cutters
- Cable Crimpers
- Needle-Nose Pliers

## Wiring the Cable

1. Use a *TOUGH Cable Connector* to gauge how much of the jacket to strip (roughly 22 mm), mark the appropriate length and strip the necessary length of cable jacket with wire strippers.



**Note:** Use caution when stripping the jacket from the cable to avoid severing the foil shield protecting the copper drain wire and twisted pair cable.

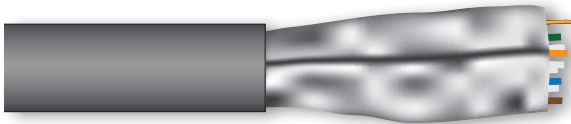
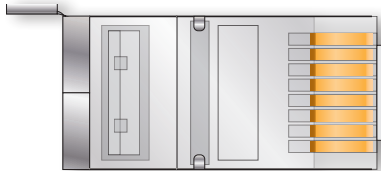

2. Carefully fold back the foil shield to expose the drain wire and twisted pair cable.



**Note:** Do not rip the foil shield completely away so that a portion of it can later be inserted into the *TOUGH Cable Connector* to terminate the connection.

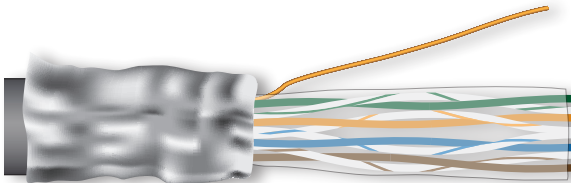

- Carefully fold back the drain wire, numbered 0 in the Cable Wiring Specification T568B (see page 8).

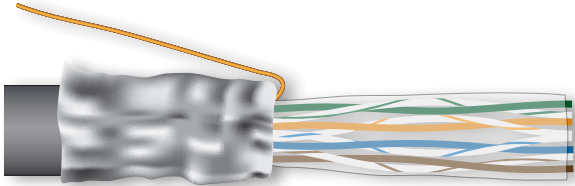

- Cut or tear away the clear plastic wrapping around the twisted pair cable and untwist the wires that are exposed.

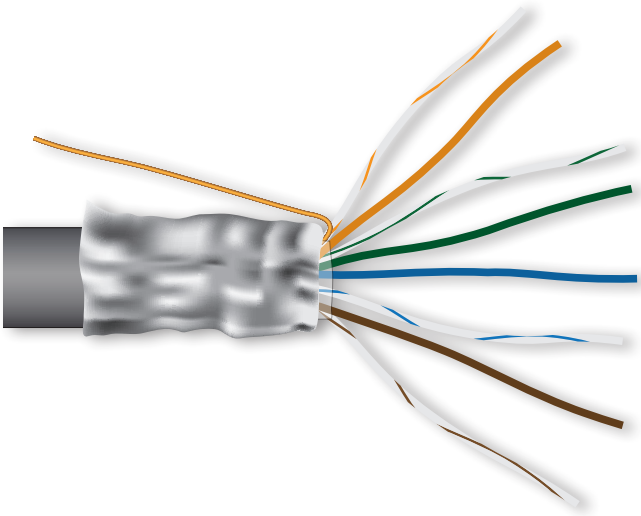

- Place the wires in order as shown below (and as detailed in the Cable Wiring Specification T568B on page 8). Ensure the wires are as straight and compact as possible.

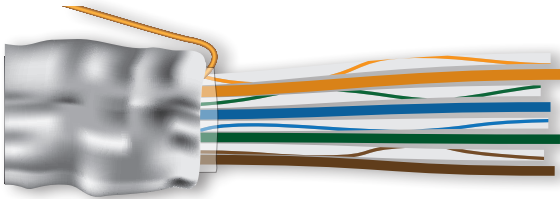

- Using wire cutters, trim the end of the wires evenly to ensure a straight surface to insert into the *TOUGH Cable Connector*.

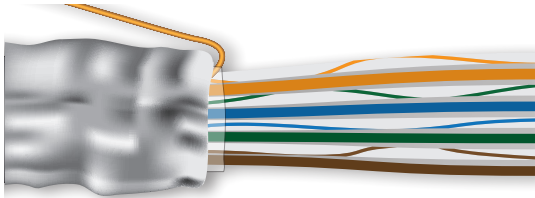

- Fold the foil shield back up towards the exposed wires; leaving roughly half the distance exposed while covering the bottom half with the foil. Fold back any excess foil.

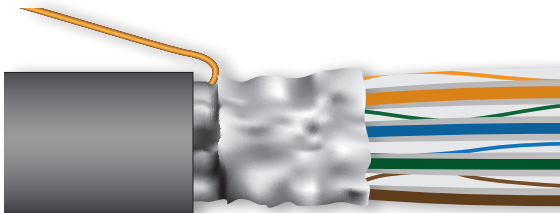

**Note:** Keep the excess foil folded back so the inside is facing out. This ensures proper conductivity of the foil. Keep the drain wire folded back, as this will loop through the drain wire hook on the outside of the connector.

8. Keeping the wires in the correct order, mold the foil firmly around the covered portion of wires and insert the wires carefully into the *TOUGH Cable Connector*.

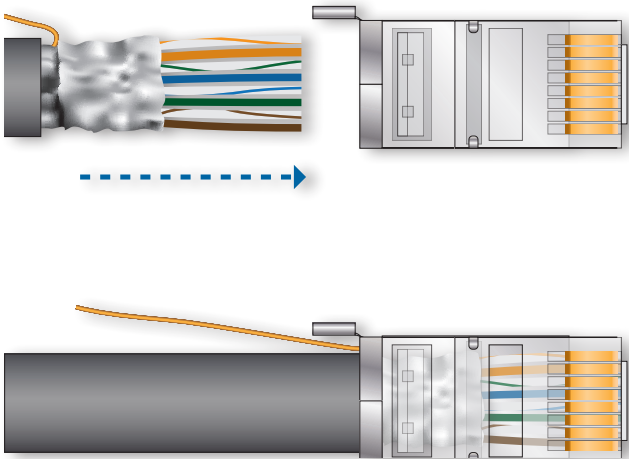

**Note:** Make sure the wires are inserted according to the Cable Wiring Specification T568B. Ensure that the wires are inserted into the *TOUGH Cable Connector* completely and that they make contact with the tip of the connector. The **folded back** (inside) portion of the foil shield must make contact with the metal inside of the *TOUGH Cable Connector* for proper termination and ESD protection. Also, for extra protection and support of the twisted wire cabling inside, ensure that the outer cable jacket fits inside the *TOUGH Cable Connector* prior to crimping in step 9.

9. Place the *TOUGH Cable Connector* and twisted pair cable into the cable crimper and press firmly.

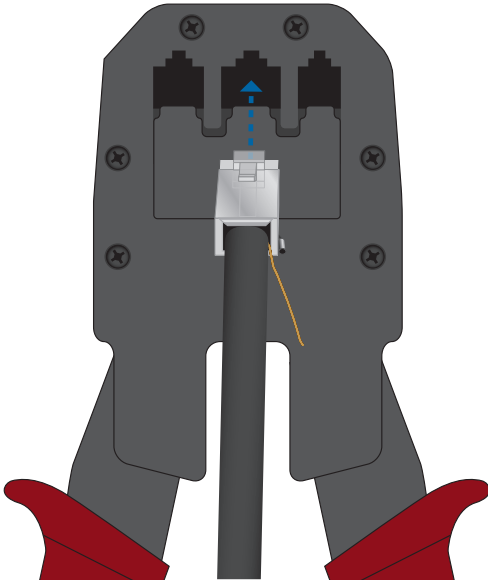

**Note:** Make sure the drain wire remains outside of the connector.

10. Feed the exposed portion of drain wire through the drain wire hook on the outside of the connector and fold it over.

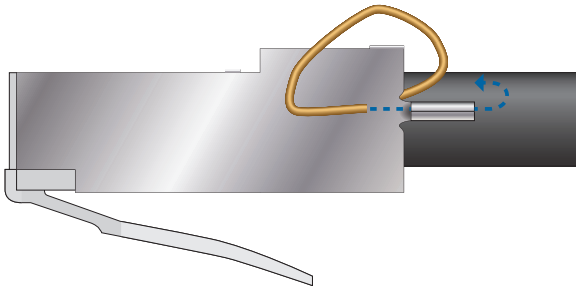



11. Crimp the drain wire hook with a pair of needle-nose pliers to create a secure contact between the drain wire and hook.

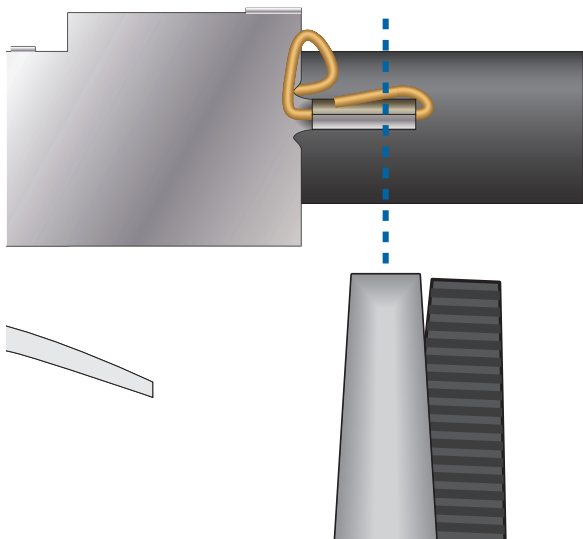

12. Repeat steps 1-11 for the other end of the cable.  
Congratulations! Your cable is ready for use.

## Cable Wiring Specification T568B



RJ45 Pin #	Wire Color	Signal Description
0	Copper (L1) or Silver (L2)	Drain Wire
1	White/Orange	BI_DA +
2	Orange	BI_DA -
3	White/Green	BI_DB +
4	Blue	BI_DC +
5	White/Blue	BI_DC -
6	Green	BI_DB -
7	White/Brown	BI_DD +
8	Brown	BI_DD -

## General Warranty

UBIQUITI NETWORKS, Inc (“UBIQUITI NETWORKS”) represents and warrants that the Products furnished hereunder shall be free from defects in material and workmanship for a period of one (1) year from the date of shipment by UBIQUITI NETWORKS under normal use and operation. UBIQUITI NETWORKS sole and exclusive obligation under the foregoing warranty shall be to repair or replace, at its option, any defective Product that fails during the warranty period. The expense of removal and reinstallation of any item is not included in this warranty.

The foregoing warranty is exclusive and in lieu of all other warranties, express or implied, including the implied warranties of merchantability and fitness for a particular purpose and any warranties arising from a course of dealing, usage or trade practice with respect to the products. Repair or replacement in the manner provided herein shall be the sole and exclusive remedy of Buyer for breach of warranty and shall constitute fulfillment of all liabilities of UBIQUITI NETWORKS with respect to the quality and performance of the Products. UBIQUITI NETWORKS reserves the right to inspect all defective Products (which must be returned by Buyer to UBIQUITI NETWORKS factory freight prepaid).

No Products will be accepted for replacement or repair without obtaining a Return Materials Authorization (RMA) number from UBIQUITI NETWORKS. Products returned without an RMA number will not be processed and will be returned to Buyer freight collect. UBIQUITI NETWORKS shall have no obligation to make repairs or replacement necessitated by catastrophe, fault, negligence, misuse, abuse, or accident by Buyer, Buyer’s customers or any other parties. The warranty period of any repaired or replaced Product shall not extend beyond its original term.

## Warranty Conditions

The foregoing warranty shall apply only if:

- (I) The Product has not been subjected to misuse, neglect or unusual physical, electrical or electromagnetic stress, or some other type of accident.
- (II) No modification, alteration or addition has been made to the Product by persons other than UBIQUITI NETWORKS or UBIQUITI NETWORK'S authorized representatives or otherwise approved by UBIQUITI NETWORKS.
- (III) The Product has been properly installed and used at all times in accordance, and in all material respects, with the applicable Product documentation.

Disclaimer: UBIQUITI NETWORKS does not warrant that the operation of the products is error-free or that operation will be uninterrupted. In no event shall UBIQUITI NETWORKS be responsible for damages or claims of any nature or description relating to system performance, including coverage, buyer's selection of products for buyer's application and/or failure of products to meet government or regulatory requirements.

## Returns

In the unlikely event a defect occurs, please work through the dealer or distributor from which this product was purchased.

## Declaration of Conformity

Česky [Czech]	UBIQUITI NETWORKS tímto prohlašuje, že tento UBIQUITI NETWORKS device, je ve shodě se základními požadavky a dále s ostatními ustanoveními směrnice 1999/5/ES.
Dansk [Danish]	Undertegnede UBIQUITI NETWORKS erklærer herved, at følgende udstyr UBIQUITI NETWORKS device, overholder de væsentlige krav og øvrige relevante krav i direktiv 1999/5/EF.
Nederlands [Dutch]	Hierbij verklaart UBIQUITI NETWORKS dat het toestel UBIQUITI NETWORKS device, in overeenstemming is met de essentiële eisen en de andere relevante bepalingen van richtlijn 1999/5/EG. Bij deze verklaart UBIQUITI NETWORKS dat deze UBIQUITI NETWORKS device, voldoet aan de essentiële eisen en aan de overige relevante bepalingen van Richtlijn 1999/5/EC.
English	Hereby, UBIQUITI NETWORKS, declares that this UBIQUITI NETWORKS device, is in compliance with the essential requirements and other relevant provisions of Directive 1999/5/EC.
Eesti [Estonian]	Käesolevaga kinnitab UBIQUITI NETWORKS seadme UBIQUITI NETWORKS device, vastavust direktiivi 1999/5/EÜ põhinõuetele ja nimetatud direktiivist tulenevatele teistele asjakohastele sätetele.
Suomi [Finnish]	UBIQUITI NETWORKS vakuuttaa täten että UBIQUITI NETWORKS device, tyypinen laite on direktiivin 1999/5/EY oleellisten vaatimusten ja sitä koskevien direktiivin muiden ehtojen mukainen.
Français [French]	Par la présente UBIQUITI NETWORKS déclare que l'appareil UBIQUITI NETWORKS device est conforme aux exigences essentielles et aux autres dispositions pertinentes de la directive 1999/5/CE. Par la présente, UBIQUITI NETWORKS déclare que ce UBIQUITI NETWORKS device, est conforme aux exigences essentielles et aux autres dispositions de la directive 1999/5/CE qui lui sont applicables.
Deutsch [German]	Hiermit erklärt UBIQUITI NETWORKS, dass sich diese UBIQUITI NETWORKS device, in Übereinstimmung mit den grundlegenden Anforderungen und den anderen relevanten Vorschriften der Richtlinie 1999/5/EG befindet". (BMWi) Hiermit erklärt UBIQUITI NETWORKS die Übereinstimmung des Gerätes UBIQUITI NETWORKS device, mit den grundlegenden Anforderungen und den anderen relevanten Festlegungen der Richtlinie 1999/5/EG. (Wien)
Ελληνική [Greek]	ΜΕ ΤΗΝ ΠΑΡΟΥΣΑ UBIQUITI NETWORKS ΔΗΛΩΝΕΙ ΟΤΙ UBIQUITI NETWORKS device, ΣΥΜΜΟΡΦΩΝΕΤΑΙ ΠΡΟΣ ΤΙΣ ΟΥΣΙΩΔΕΙΣ ΑΠΑΙΤΗΣΕΙΣ ΚΑΙ ΤΙΣ ΛΟΙΠΕΣ ΣΧΕΤΙΚΕΣ ΔΙΑΤΑΞΕΙΣ ΤΗΣ ΟΔΗΓΙΑΣ 1999/5/ΕΚ.
Magyar [Hungarian]	Alulírott, UBIQUITI NETWORKS nyilatkozom, hogy a UBIQUITI NETWORKS device, megfelel a vonatkozó alapvető követelményeknek és az 1999/5/EC irányelv egyéb előírásainak.

Íslenska [Icelandic]	Hér me l sir UBIQUITI NETWORKS yfir ví a UBIQUITI NETWORKS device, er í samræmi við grunnkröfur og a rar kröfur, sem ger ar eru í tilskipun 1999/5/EC.
Italiano [Italian]	Con la presente UBIQUITI NETWORKS dichiara che questo UBIQUITI NETWORKS device, è conforme ai requisiti essenziali ed alle altre disposizioni pertinenti stabilite dalla direttiva 1999/5/CE.
Latviski [Latvian]	Ar o UBIQUITI NETWORKS deklar , ka UBIQUITI NETWORKS device, atbilst Direkt vas 1999/5/EK b tiskaj m pras b m un citiem ar to saist tajiem noteikumiem.
Lietuviškai [Lithuanian]	UBIQUITI NETWORKS deklaruoja, kad šis UBIQUITI NETWORKS įrenginys atitinka esminius reikalavimus ir kitas 1999/5/EB Direktyvos nuostatas.
Malti [Maltese]	Hawnhekk, UBIQUITI NETWORKS, jiddikjara li dan UBIQUITI NETWORKS device, jikkonforma mal- ti ijjiet essenzjali u ma provvedimenti o rajn relevanti li hemm fid-Direttiva 1999/5/EC.
Norsk [Norwegian]	UBIQUITI NETWORKS erklærer herved at utstyret UBIQUITI NETWORKS device, er i samsvar med de grunnleggende krav og øvrige relevante krav i direktiv 1999/5/EF.
Slovensky [Slovak]	UBIQUITI NETWORKS týmto vyhlasuje, e UBIQUITI NETWORKS device, sp a základné požiadavky a v etky príslu né ustanovenia Smernice 1999/5/ES.
Svenska [Swedish]	Härmed intygar UBIQUITI NETWORKS att denna UBIQUITI NETWORKS device, står i överensstämmelse med de väsentliga egenskapskrav och övriga relevanta bestämmelser som framgår av direktiv 1999/5/EG.
Español [Spanish]	Por medio de la presente UBIQUITI NETWORKS declara que el UBIQUITI NETWORKS device, cumple con los requisitos esenciales y cualesquiera otras disposiciones aplicables o exigibles de la Directiva 1999/5/CE.
Polski [Polish]	Niniejszym, firma UBIQUITI NETWORKS o wiadcza, e produkt serii UBIQUITI NETWORKS device, spełnia zasadnicze wymagania i inne istotne postanowienia Dyrektywy 1999/5/EC.
Português [Portuguese]	UBIQUITI NETWORKS declara que este UBIQUITI NETWORKS device, está conforme com os requisitos essenciais e outras disposições da Directiva 1999/5/CE.
Română [Romanian]	Prin prezenta, declarăm că acest produs este în conformitate cu cerințele esențiale și cu alte prevederi relevante din Directiva 1999/5/CE.



## Ubiquiti Networks Support

Email: **support@ubnt.com**

Phone (9 a.m. - 5 p.m. PST): **408-942-1153**

## Online Resources

Wiki Page: **www.ubnt.com/wiki**

Support Forum: **www.ubnt.com/forum**

Downloads: **www.ubnt.com/support/downloads**

