



airFiber[®] X Antenna

Slant 45 Antenna for airFiber[®]

Model: AF-2G24-S45, AF-3G26-S45,
AF-5G23-S45, AF-5G30-S45, AF-5G34-S45

Powerful Performance for Long-Range Links

Robust Design and Construction for Outdoor Use

Seamless Integration with airFiber Radio

Overview

Pair an airFiber® X antenna with an airFiber X radio to create the endpoint of a high-performance, Point-to-Point (PtP) bridge or network backhaul (airFiber X radio sold separately).

The airFiber X antenna uses the 5 GHz frequency band and is available for the following frequency bands:

- 2.4 GHz
- 3 GHz
- 4 GHz
- 5 GHz

Powerful Performance

The airFiber X antenna delivers 2x2, dual-polarity performance. On the right is one example of how the airFiber X antenna with an airFiber X radio can be deployed as endpoints in a backhaul link to deliver bandwidth from a WISP network out to a neighborhood tower. From there, an airMAX® Sector antenna with a Rocket® radio delivers bandwidth to the WISP's customers.

Carrier-Class Construction

Incorporating a dish reflector design for excellent beam directivity, the airFiber X antennas feature robust mechanical design using industrial-strength hardware for outdoor application use.

Plug and Play Integration

airFiber X antennas and airFiber X radios have been designed to seamlessly work together. Every airFiber X antenna has a built-in airFiber X radio mount, so installation requires no special tools.

Snap the airFiber X radio securely into place and mount the antenna; you then have the optimal combination of airFiber X antenna and airFiber X radio for your PtP application.

Application Example

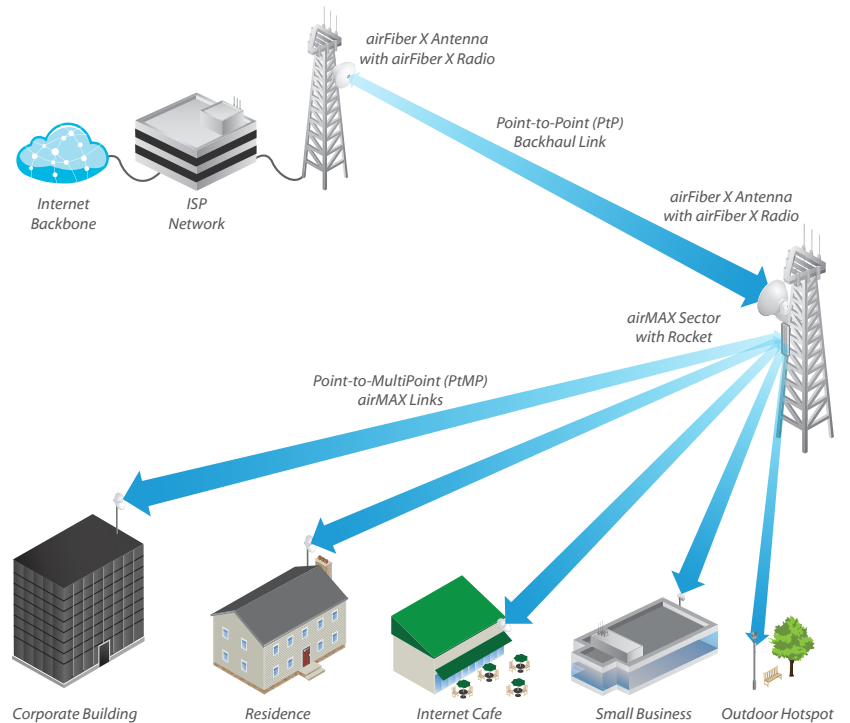

Mounting the AF-5X on the AF-5G23-S45

Hardware Overview

Innovative Mechanical Design

- **Secure Pole-Mounting** Maintains the position of the dish during harsh outdoor conditions.
- **Low-Profile Form Factor of the AF-5G23-S45** Reduces wind-loading.

Weatherproof Design

- **Protective Shroud** Protects the cables and connectors from the elements.
- **Integrated Radome of the AF-5G23-S45** Shields the radio from the environment.

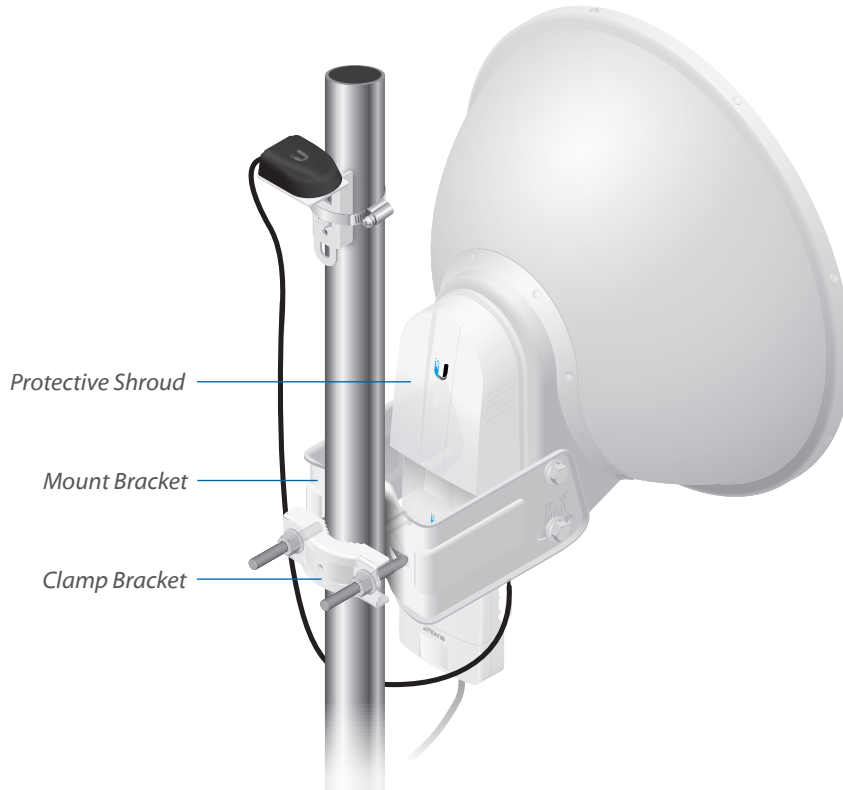

Advanced RF Isolation Design

Model: AF-5G23-S45

The innovative industrial design improves RF isolation to significantly reduce interference and deliver superior gain for high-capacity, multipoint networks.

The near-field plot of the AF-5G23-S45 is displayed in watts and uses a linear scale. The strength of the electromagnetic field is color-coded:

- Red: Highest strength
- Green: Medium strength
- Indigo: Lowest strength

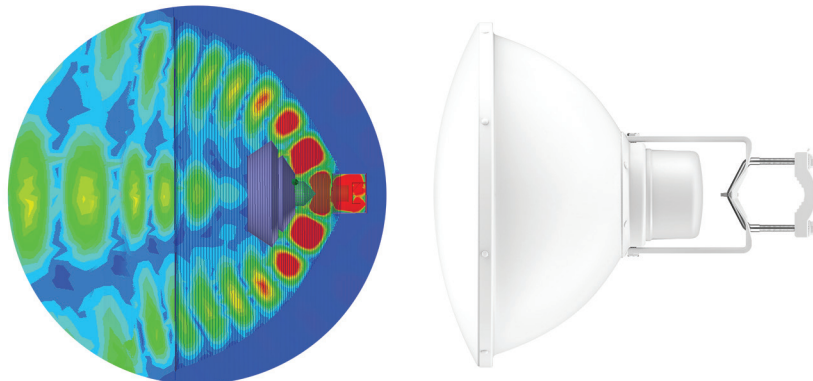

Deployment Flexibility

The airFiber X supports $\pm 45^\circ$ slant polarization for improved noise immunity and Signal-to-Noise Ratio (SNR). The compact form factor of the airFiber X allows it to fit into the radio mount of Ubiquiti antennas, so installation requires no special tools.

The airFiber X antennas are purpose-built with 45° slant polarity for seamless integration with the airFiber X.

airFiber® X Antenna

2.4 GHz Model



Model	Frequency	Gain	Radome*
AF-2G24-S45	2.4 GHz	24 dBi	RAD-RD2

The AF-2G24-S45 offers 24 dBi of gain in a 650-mm diameter size.

airFiber® X Antenna

3 GHz Model



Model	Frequency	Gain	Radome*
AF-3G26-S45	3 GHz	26 dBi	RAD-RD2

The AF-3G26-S45 offers 26 dBi of gain in a 650-mm diameter size.

5 GHz Models



Model	Frequency	Gain	Radome
AF-5G23-S45	5.1 - 5.9 GHz	23 dBi	Integrated

Housed in a compact form factor (378-mm diameter size), the AF-5G23-S45 offers 23 dBi of gain and features the following advantages:

- Low sidelobes reduce interference from other transmitters in the area.
- High isolation enhances performance for co-location in tower-mounted installations.
- The low-profile design with integrated radome reduces wind-loading.



Model	Frequency	Gain ¹	Radome ²
AF-5G30-S45	4.9 - 5.9 GHz	26 - 30 dBi	ISO-BEAM-620

The AF-5G30-S45 offers up to 30 dBi of gain in a 650-mm diameter size.



Model	Frequency	Gain ¹	Radome ²
AF-5G34-S45	4.9 - 5.8 GHz	30 - 34 dBi	RAD-RD3

The AF-5G34-S45 offers up to 34 dBi of gain in a 1050-mm diameter size.

¹ Check your local/regional regulations for the maximum antenna gain allowed for your application.

² A radome is available as an optional accessory.

airFiber® X Antenna AF-5G30-S45 Accessories

IsoBeam™

Model: ISO-BEAM-620



The IsoBeam™ is an isolator radome that is available as an optional accessory for the AF-5G30-S45 and other dish antenna models:

- RocketDish® RD-5G30-LW
- PowerBeam™ PBE-5AC-620
- PowerBeam PBE-M5-620

The innovative RF-choke perimeter of the IsoBeam delivers superior noise immunity in co-location deployments; its perimeter corrugation provides enhanced RF shielding. Compare the two near-field plots below, and note the breakthrough isolation performance of the IsoBeam.

Both near-field plots are displayed in watts and use a linear scale. The strength of the electromagnetic field is color-coded:

- Red: Highest strength
- Green: Medium strength
- Indigo: Lowest strength

Without IsoBeam

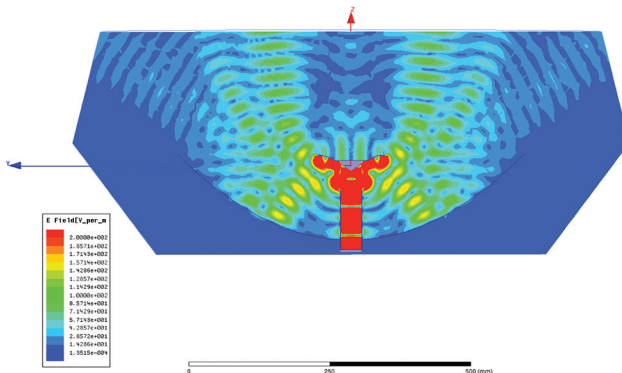

With IsoBeam

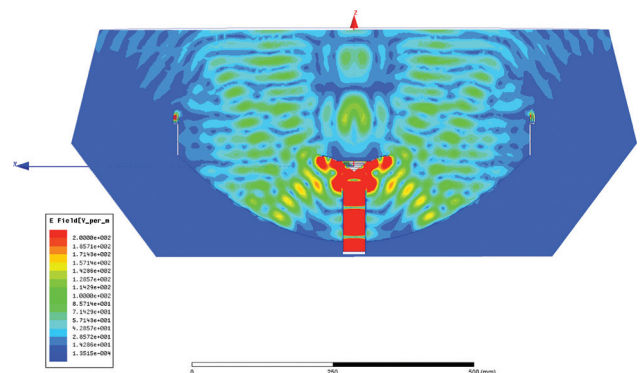

Precision Alignment Kit

Model: PAK-620

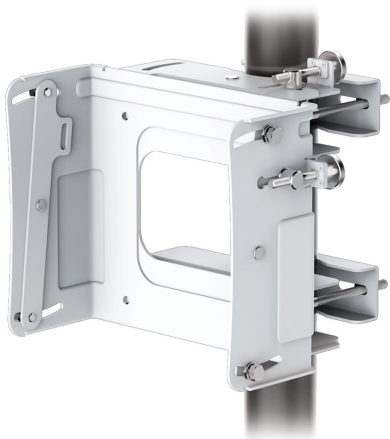

The Precision Alignment Kit is available as an optional accessory for the AF-5G30-S45. It features 15° of azimuth adjustment and 15° of elevation adjustment to enable extremely accurate aiming for optimal PtP link performance.

The Precision Alignment Kit is also compatible with other dish antenna models:

- RocketDish RD-5G30-LW
- PowerBeam PBE-5AC-620
- PowerBeam PBE-M5-620

Specifications

Antenna Characteristics					
Model	AF-2G24-S45	AF-3G26-S45	AF-5G23-S45	AF-5G30-S45	AF-5G34-S45
Dimensions*	ø 650 x 295 mm (ø 25.59 x 11.61")	ø 650 x 300 mm (ø 25.59 x 11.81")	ø 378 x 290 mm (ø 14.88 x 11.42")	ø 650 x 386 mm (ø 25.59 x 15.20")	ø 1050 x 421 mm (ø 41.34 x 16.57")
Weight**	9.8 kg (21.61 lb)	9.8 kg (21.61 lb)	3.4 kg (7.50 lb)	7.4 kg (16.31 lb)	13.5 kg (29.76 lb)
Frequency Range	2.3 - 2.7 GHz	3.3 - 3.8 GHz	5.1 - 5.9 GHz	4.9 - 5.9 GHz	4.9 - 5.8 GHz
Gain	24 dBi	26 dBi	23 dBi	4.9 GHz: 26 dBi 5 - 5.9 GHz: 30 dBi	4.9 GHz: 30 dBi 5 - 5.8 GHz: 34 dBi
+ 45° Beamwidth	6.6° (3 dB)	7° (3 dB)	10° (3 dB)	5.8° (3 dB)	3° (3 dB)
- 45° Beamwidth	6.8° (3 dB)	7° (3 dB)	10° (3 dB)	5.8° (3 dB)	3° (3 dB)
F/B Ratio	28 dB	33 dB	30 dB	30 dB	42 dB
Max. VSWR	1.6:1	1.4:1	1.5:1	1.6:1	1.4:1
Wind Loading	787 N @ 200 km/h (177 lbf @ 125 mph)	787 N @ 200 km/h (177 lbf @ 125 mph)	190 N @ 200 km/h (43 lbf @ 125 mph)	790 N @ 200 km/h (178 lbf @ 125 mph)	1,779 N @ 200 km/h (400 lbf @ 125 mph)
Wind Survivability	200 km/h (125 mph)				
Polarization	Dual-Linear				
Cross-pol Isolation	35 dB Min.				
ETSI Specification	EN 302 326 DN2				
Mounting	Universal Pole Mount, airFiber X Radio Bracket, and Weatherproof RF Connectors Included				

* Dimensions exclude pole mount and airFiber X radio (airFiber X radio sold separately)

** Weight includes pole mount and excludes airFiber X radio (airFiber X radio sold separately)

AF-2G24-S45 Antenna Information

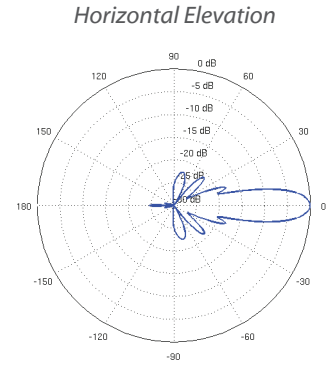
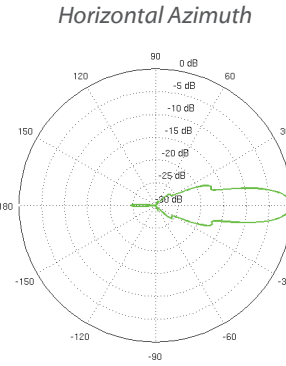
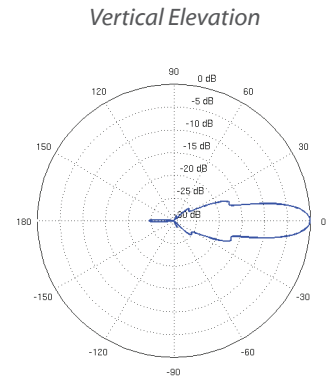
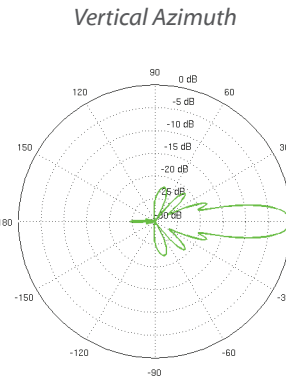
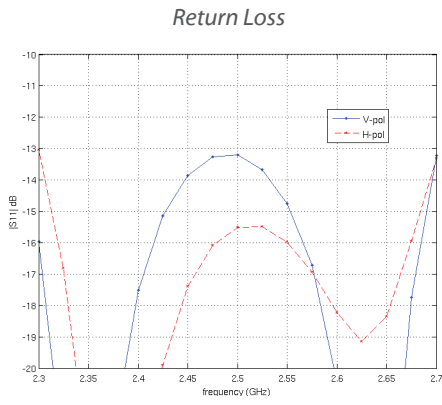

AF-3G26-S45 Antenna Information

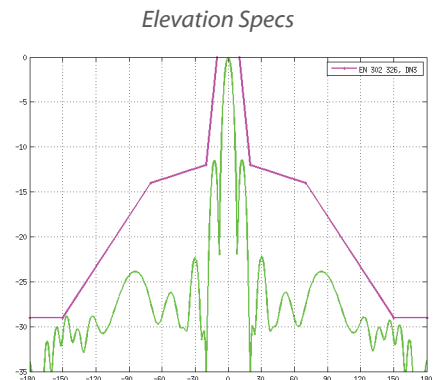
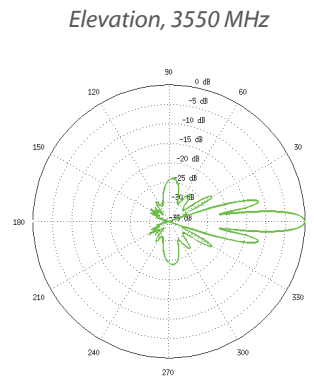
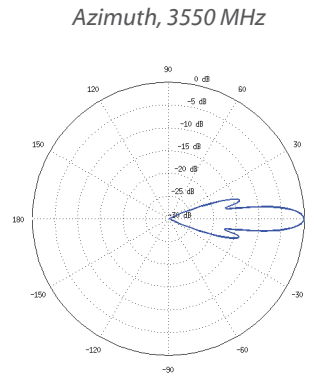
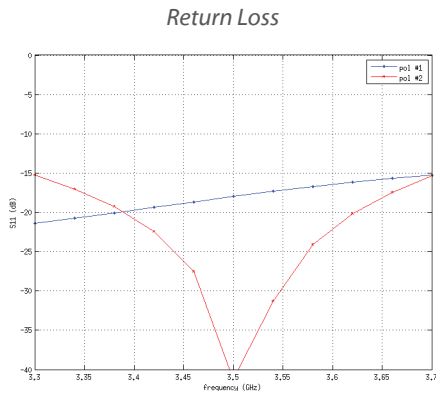

AF-5G23-S45 Antenna Information

Return Loss

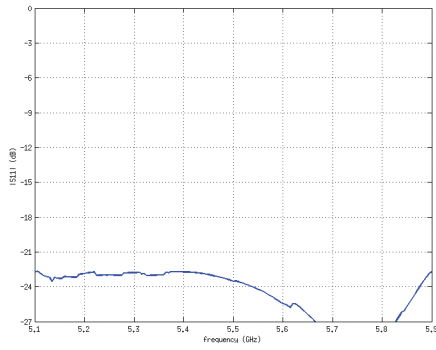

Azimuth, 5500 MHz

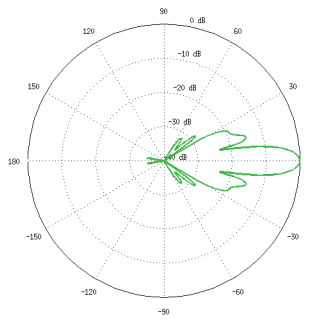

Azimuth Specs

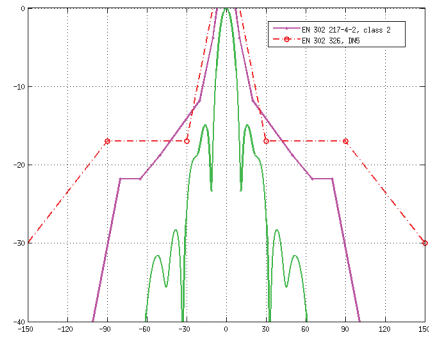

Elevation, 5500 MHz

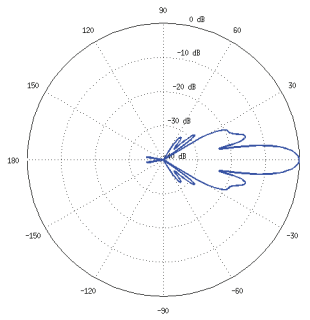

Elevation Specs

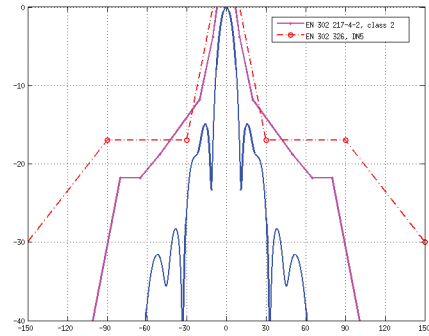

AF-5G30-S45 Antenna Information

Return Loss

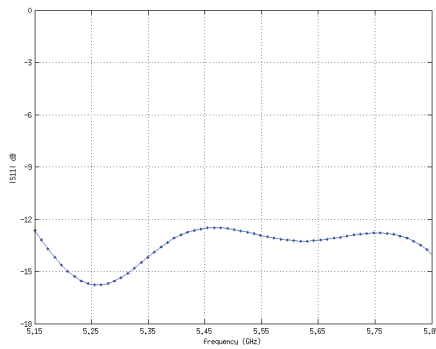

Azimuth, 5500 MHz

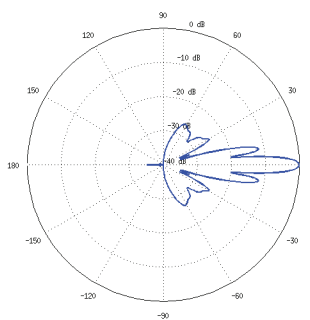

Azimuth Specs

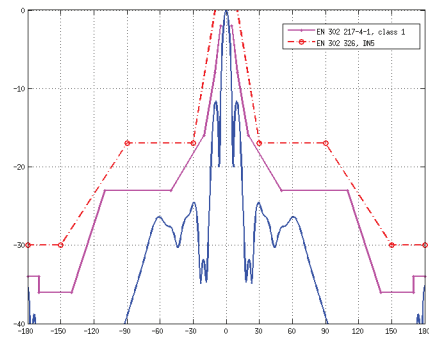

Elevation, 5500 MHz

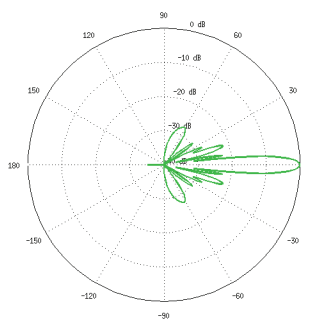

Elevation Specs

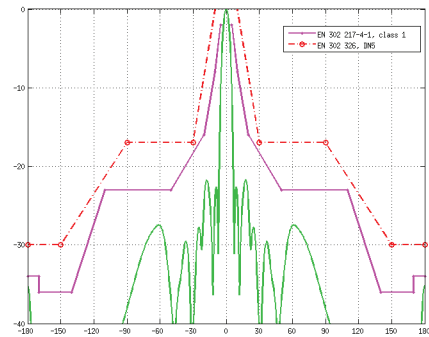

AF-5G34-S45 Antenna Information

Azimuth, 5500 MHz

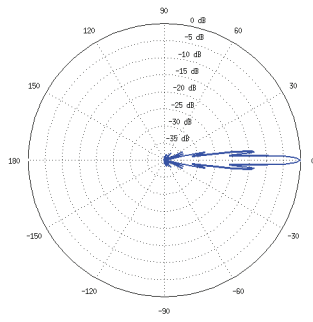

Azimuth Specs

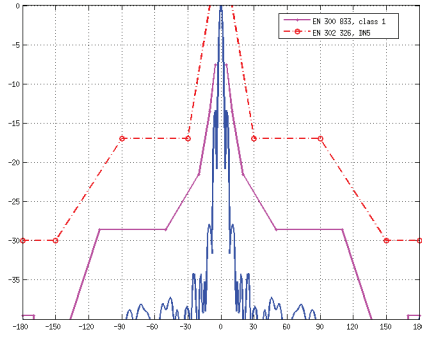

Elevation, 5500 MHz

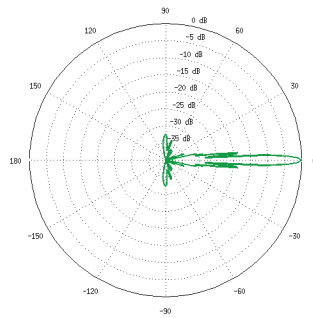

Elevation Specs

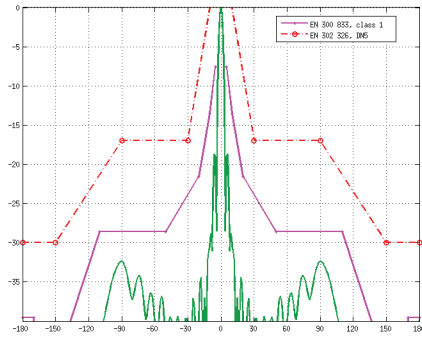

Specifications are subject to change. Ubiquiti products are sold with a limited warranty described at: www.ubnt.com/support/warranty
 ©2015-2016 Ubiquiti Networks, Inc. All rights reserved. Ubiquiti, Ubiquiti Networks, the Ubiquiti U logo, the Ubiquiti beam logo, airFiber, airMAX, airOS, IsoBeam, PowerBeam, Rocket, and RocketDish are trademarks or registered trademarks of Ubiquiti Networks, Inc. in the United States and in other countries. All other trademarks are the property of their respective owners.



www.ubnt.com